

Creek CD53 & CD50

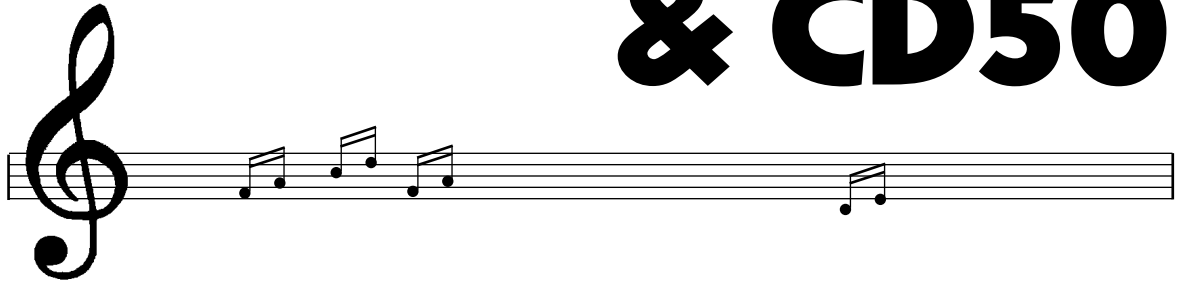

Compact Disc Players

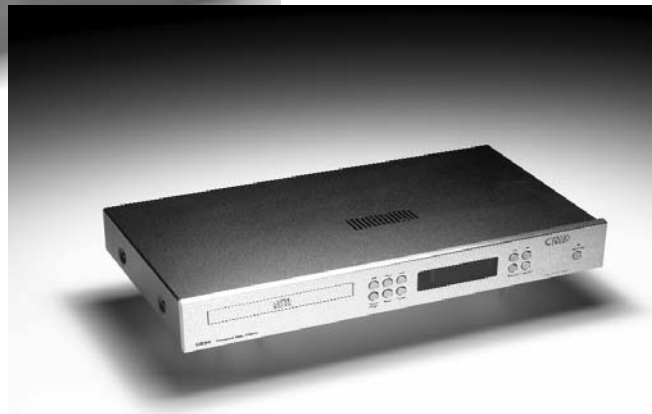

Operating Instructions

CONGRATULATIONS ON YOUR PURCHASE

Your new Compact Disc Player is designed to provide maximum enjoyment and years of trouble free service. If this is your first CD player, you will find the compact disc system a major step forward in the science of audio technology. By employing the most sophisticated digital and optical technologies, the compact disc not only offers the ultimate in sound reproduction, it also provides operating features which have never been seen before in audio equipment designed for home, such as fast access to any track on the disc, very simple programming and armchair control.

Please read this manual thoroughly. It will explain the features and operation of your CD Player and help to ensure a trouble free installation. Please unpack your CD Player carefully. We recommend that you save the carton and packing material, as they will be helpful should you ever need to move your unit or return it for service.

Your CD Player is designed to work in a horizontal position and it is important to allow at least two inches of space behind the unit for adequate ventilation and for the cables. To avoid damage, never place the unit near radiators, in front of heating vents, in direct sunlight or in an excessively humid or dusty location.

SAFETY INFORMATION

This CD player is designed to operate on 220-240 Volts 50Hz AC or 110-120 Volts 60 Hz AC. Normally the equipment is supplied with a mains lead with a fitted 3 pin plug suitable for the country it is to be used in. If the plug needs to be changed, please follow the instructions below.

PLUG FITTING INSTRUCTIONS

The wires in the mains lead are coloured in accordance with the following code:

Blue	-	Neutral
Brown	-	Live
Green / Yellow	-	Earth

In the UK the wires must be connected to the terminals in the plug as follows:

Blue	-	N or Black
Brown	-	L or Red
Green / Yellow	-	E or Earth

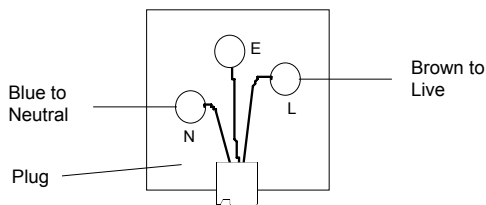

NOTE

1. In the UK a 13-amp plug is used and should be fitted with a 3 Amp fuse.
2. If a 3-pin plug with earthing contact is used, the Green/Yellow wire must be connected to the E terminal.
3. As with all electrical equipment, it is recommended that the mains plug is removed from the wall socket when not in use.

TO ACHIEVE MAXIMUM PERFORMANCE FROM YOUR CD PLAYER:

1. **Install** the equipment in a location which is relatively free of moisture and dust, and which is well ventilated.
2. Avoid installing the equipment in a location exposed to direct sunlight or extreme heat (such as above a heater or radiator).
3. The equipment may not be able to perform at its best in an extremely cold or hot environment. Do not attempt to use below 41°F/5°C or above 95°F/35°C.
4. Always **handle discs** with clean hands. Avoid using scratched discs..
5. Keep this manual in a safe place for future reference.
6. Do not attempt to clean the CD player or CD discs with chemical solvents, as this may cause irreparable damage. Use a clean, dry cloth, or specially designed cleaning materials for discs.
7. If the CD player malfunctions, **do not open the unit and attempt to repair it yourself**. This is a highly technical product and requires specialist service - return it to your dealer.
8. Use **batteries** (2 x AAA) of the same type in the remote control handset. The use of odd or different type cells will affect its performance. Batteries are supplied.

UK ONLY: FOR ADDED SAFETY, WHEN CONNECTING THE AC MAINS LEAD TO A 3 PIN PLUG USE A 3A FUSE APPROVED BY ASTA TO BS1362 - WITH ASA MARK

SAFETY WARNINGS

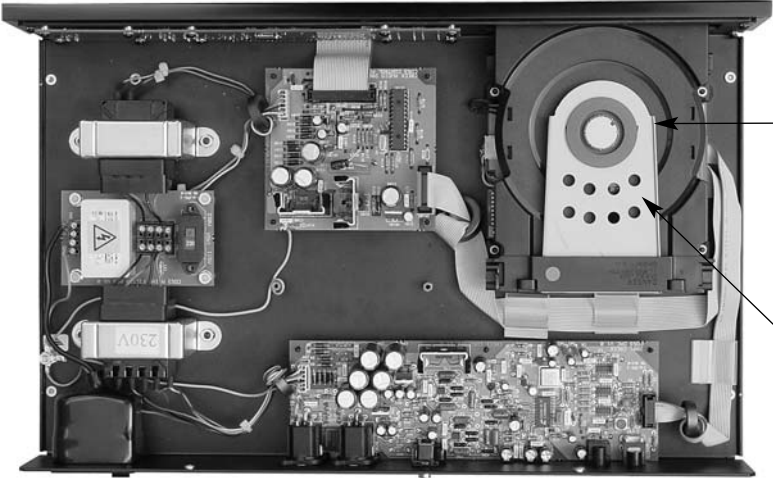

CAUTION!
Invisible laser radiation when top cover is removed.



CAUTION
PERFORMING ADJUSTMENTS OR PROCEDURES OTHER THAN THOSE SPECIFIED HERE MAY RESULT IN HAZARDOUS EXPOSURE.

THE CD PLAYER SHOULD NOT BE REPAIRED BY ANYONE EXCEPT QUALIFIED SERVICE PERSONNEL.

Class 1 Laser Product

SPECIFICATION

Power requirements and fuse rating:	AC 220-240 V 50 Hz - T 250 mA AC 110-120 V 60 Hz - T 500 mA
Power consumption	20 W max 6 W standby
Frequency response	1 Hz - 20 kHz ± 0.25 dB
Output level, unbalanced	2.2 V RMS at 1kHz, 0 dB
Balanced	4.4 V RMS at 1kHz, 0dB
Output impedance	100 W , min load 1 kW
Output balanced	200 W , min load 1 kW
Laser type	Semiconductor ALGaAs
Wavelength	790 nm ± 25 nm
Light output (cw)	0.18 mW typical
Signal to noise ratio	better than 96dB's
Dynamic range	better than 96dB's
Number of channels	2
Total harmonic distortion	< 0.0015% at 1 kHz, 0 dB
Dimensions CD53	43 x 7 x 25 cm
Dimensions CD50	43 x 6 x 23 cm
Weight	5 Kgs

OTHER FEATURES

1. Infra-red remote control.
2. High precision DS digital to analogue conversion.
3. Advanced DEM (dynamic element matching) technology.
4. Low jitter filtered master clock
5. 3-beam optical laser pick up.
6. 16 program memory.
7. VFD display.
8. Shuffle function (random selection).
9. Repeat facility.
10. Intro scan facility.
11. A-B playback facility

Note:
The specification and design are subject to change for improvements without notice.

NOTE

The equipment has been tested and found to comply with the limits for a Class B digital device, pursuant to Part 15 of the FCC Rules. These limits are designed to provide reasonable protection against harmful interference in residential installations.

This equipment generates and can radiate radio frequency energy and if not installed and used in accordance with the instructions may cause interference to radio communications. However, there is no guarantee that interference will not occur in some instances. If this product causes interference to radio or television reception, which can be determined by turning the equipment off and on, try to correct this by one or more of the following measures:

- Reorient or relocate the receiving antenna.
- Increase the separation between the equipment and the radio or TV receiver.
- Connect the equipment into a mains outlet on a circuit different from that to which the receiver is connected.
- Consult the dealer or an experienced radio/TV technician.

CONNECTING THE COMPACT DISC PLAYER

CAUTION

- ◆ Before connecting or disconnecting a unit from your audio system, make sure that you switch off the power to each component.
- ◆ Ensure that you make the correct connections, paying attention to the **L** (left channel) and **R** (right channel) marks. Plug in the cable securely. Loose connections will result in unsatisfactory sound reproduction or noise problems.
- ◆ If this unit interferes with the tuner, switch it off during tuner operation.

1. LINE OUT SOCKETS

Connect one end of the interconnect cable to the unit's AUDIO OUTPUT sockets and the other end to the sockets labelled **CD** or **AUX**, or to other line inputs on the amplifier.

Do not connect it to the amplifier's PHONO input if a phono circuit is installed.

2. DIGITAL OUTPUT

This output enables you to connect the CD player to a stand-alone D to A converter in order to change the signal into a stereo analogue one. The digital output can be accessed via the co-axial SPDIF socket on the rear panel.

3. AC POWER SOCKET, IEC TYPE

220V-240 V AC or 110V-120 V AC

4. AC POWER CORD

After completing the installation and all connections, make sure that the **POWER** switch on the back panel of the unit is set to OFF (O).

Then plug the power cord into a live AC outlet.

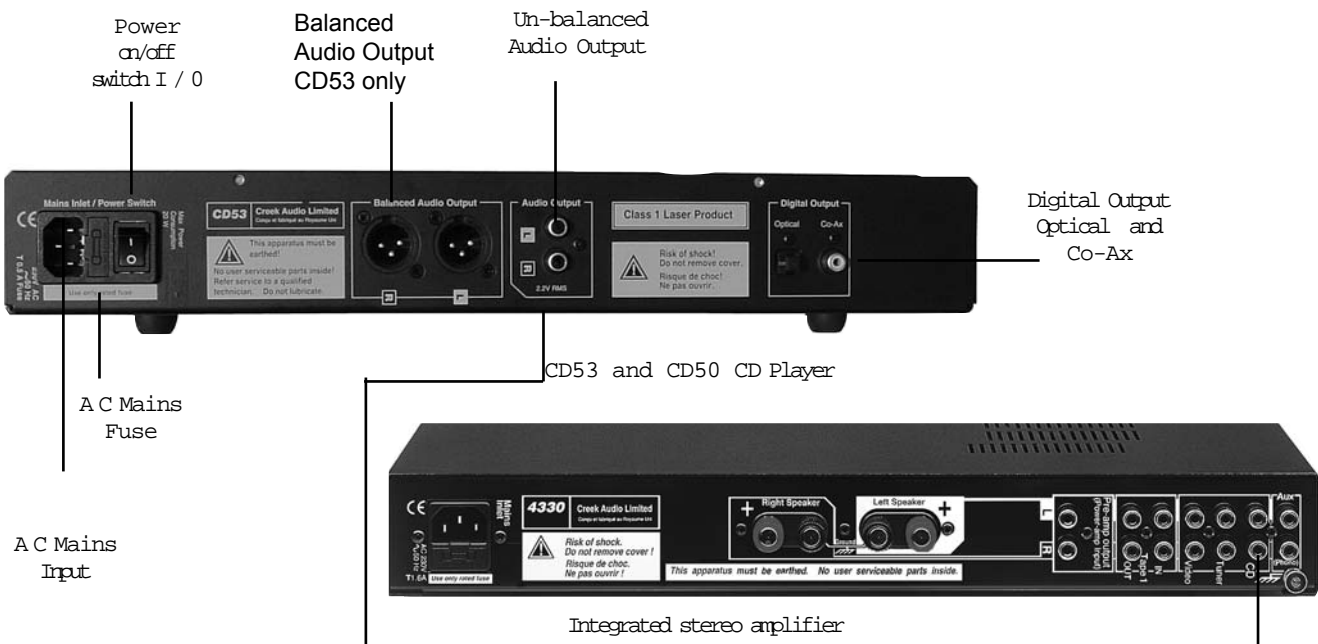

WARNING
 UNAUTHORISED RECORDING OF COPYRIGHT MATERIAL MAY VIOLATE APPLICABLE COPYRIGHT LAWS. THE DISTRIBUTOR ASSUMES NO RESPONSIBILITY FOR THE UNAUTHORISED DUPLICATION, USE OR OTHER ACTS, WHICH INFRINGE UPON THE RIGHTS OF COPYRIGHT OWNERS.

EXPLANATION OF CONTROLS

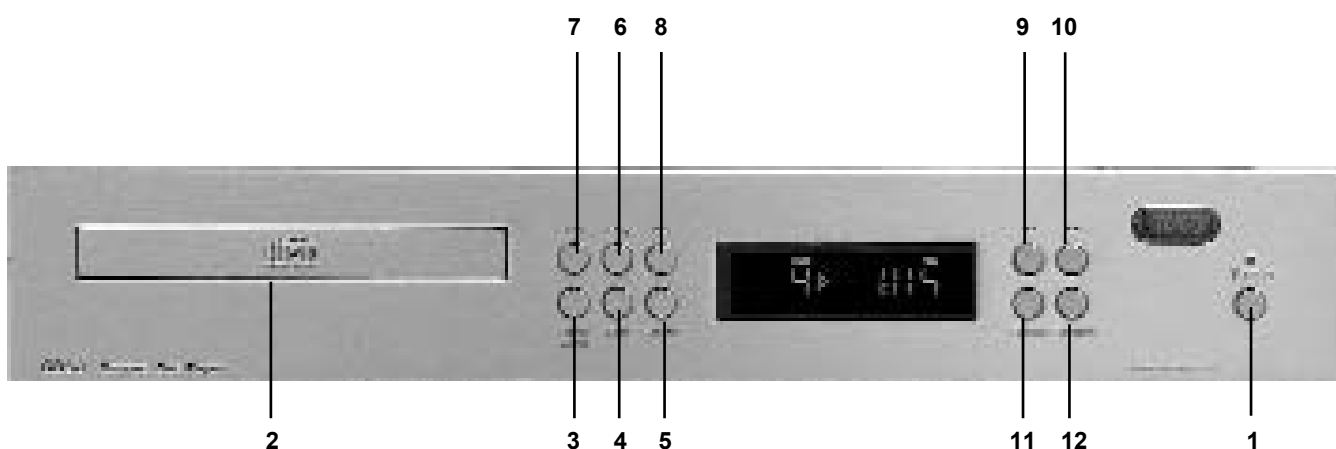

MAIN UNIT

- | | |
|-----------------------------|--------------------------------|
| 1. STANDBY button | 7. SKIP BACK button |
| 2. Disc Tray | 8. SKIP FORWARD button |
| 3. OPEN/CLOSE button | 9. SCAN BACK button |
| 4. STOP button | 10. SCAN FORWARD button |
| 5. PAUSE button | 11. REPEAT button |
| 6. PLAY button | 12. SHUFFLE button |

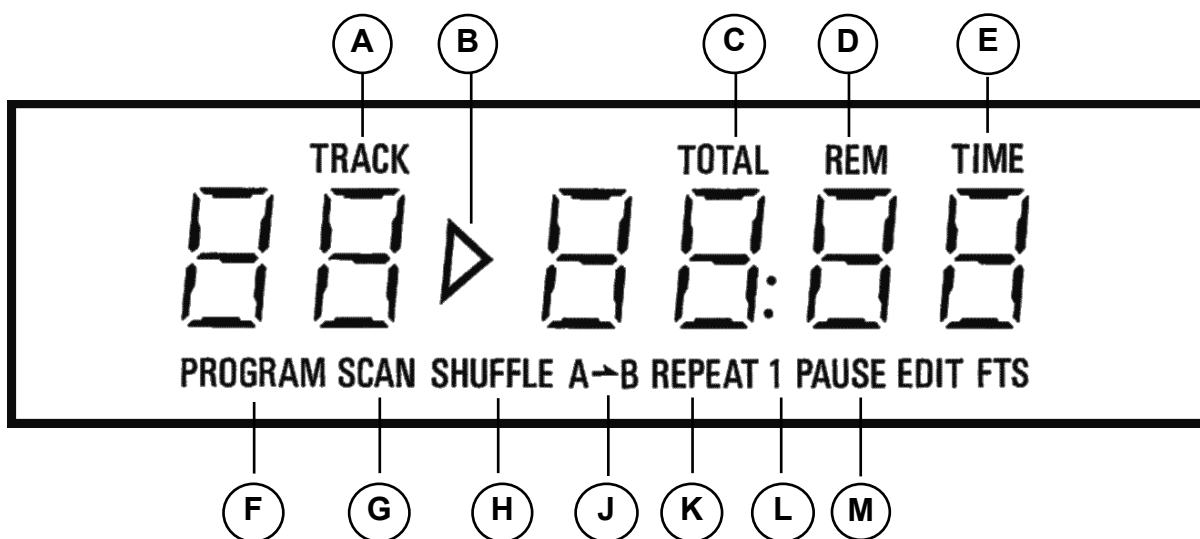





DISPLAY WINDOW

- | | |
|------------------------------------|----------------------------------|
| A. TRACK NUMBER display | G. SCAN indicator |
| B. PLAY indicator | H. SHUFFLE PLAY indicator |
| C. TOTAL TIME indicator | J. A « B PLAY indicator |
| D. REMAIning time indicator | K. REPEAT indicator |
| E. PLAYING TIME display | L. REPEAT 1 indicator |
| F. PROGRAM indicator | M. PAUSE indicator |

EXPLANATION OF CONTROLS



REMOTE CONTROL UNIT

- A. STANDBY 
- B. NUMERICAL track selection 
- C. PROGRAM 
- D. REPEAT A ↔ B 
- E. REMAINING TIME 
- F. REPEAT 
- G. SKIP TRACK  back &  forward
- H. SEARCH  back &  forward
- I. PLAY  
- J. OPEN/CLOSE 
- K. STOP  
- L. PAUSE 

COMPACT DISCS

HANDLING THE DISCS

This unit has been designed to play Compact Discs bearing the identification logo shown below. DVD discs cannot be played.



- ◆ Always place the CD in the disc tray with the label facing up. CD's can only be played on one side.
- ◆ To remove a CD from its storage case, press down on the centre of the case and lift the disc out, holding it carefully by the edges.

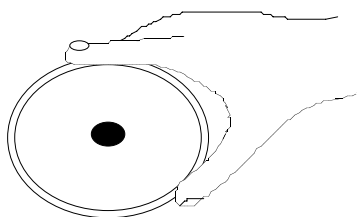

- ◆ Fingerprints and dust should be carefully wiped off the CD's signal surface (glossy side) with a soft dry cloth. Unlike a conventional record, the CD has no grooves to collect dust and microscopic debris, so gently wiping it with a soft dry cloth should remove most particles.
- ◆ Wipe the disc in a straight motion from the inside out. Small dust particles and stains will have absolutely no effect on reproduction quality.
- ◆ Never use chemicals such as record sprays, antistatic sprays or fluids, benzine or thinners to clean a compact disc. Such chemicals would irreparably damage the surface.
- ◆ Store the discs in their cases when not in use to avoid serious scratches which could cause the laser pickup to skip.
- ◆ Do not expose the discs to direct sunlight, high humidity, or high temperatures for extended periods. Long exposure to high temperatures can warp the discs.
- ◆ Do not stick paper or write anything with a ballpoint pen on the disc surface.

LOADING DISCS

1. Switch the power on at the back of the unit. Press any button on the front panel or remote handset to return from **Standby**.
2. Press the **OPEN/CLOSE** button on the front or **DISC** on the handset. The disc tray will open. If the disc tray gets jammed while opening, it will stop and close automatically.
3. When the disc tray has opened fully, take a normal size (12 cm) disc from its case and place it carefully in the tray with the label facing up. To play an 8 cm single place it in the inner groove of the tray with the label facing up.

NOTE: Only load one disc at a time. The side opposite the label is the signal side. Handle the disc carefully to avoid leaving fingerprints on its surface.

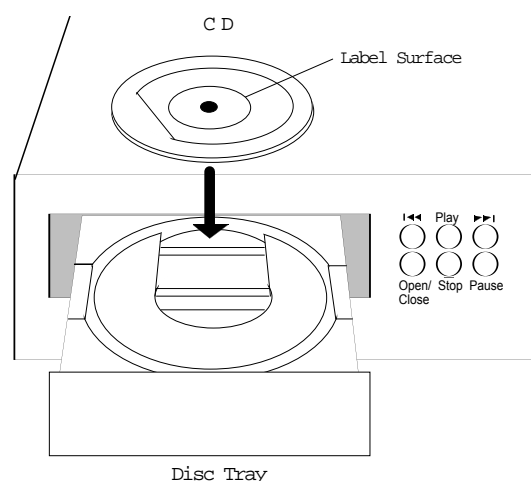

4. To close the disc tray, press the **OPEN/CLOSE** button (**DISC** button on remote) again or gently push the tray in.

When the tray is fully closed, with a correctly loaded disc, the disc will start turning automatically and the TOC (table of contents) will be read. The disc will then stop and the TOC will be displayed, i.e. the total **number of tracks** on the disc and the total **playing time** of the disc. The CD player is now ready to play.

NOTE: If after you load the disc you press the **PLAY** button to close the tray, the disc will automatically start playing from the beginning of track one.

REMOVING THE DISC

The disc tray can be opened at any time by pressing the **OPEN/CLOSE** button. Remove the disc only after the tray has fully opened.

CAUTION

- ◆ Do not put anything except a Compact Disc into the tray. Foreign objects can damage the mechanism. DVD's will not play.

- ◆ Do not force the tray by hand during the opening and closing operations.
- ◆ To avoid dirt and dust entering the mechanism, keep the disc tray closed when the CD player is not in use.
- ◆ Never load two discs into the disc tray.

CONTROL AND OPERATION

This section describes the CD player's controls in the order in which you would normally use them. Follow the instructions step-by-step and you will easily master the operation of the unit.

POWER

The mains On/Off switch is located on the rear panel next to the power cord. The marking on the panel. **1** is on and **0** is off.

Switching on the power from the rear panel automatically places the unit in Standby mode. To wake it up, press the **ANY BUTTON** button on the front panel or remote handset. The LED indicator will alternate from yellow colour in Standby mode to green when ready to play.

OUTPUTS

The CD 53 and CD50 both have un-balanced RCA/Phono sockets which output an analogue signal to your amplifier. The CD53 also has professional standard symmetrical balanced outputs which can only be used together with amplifiers that have balanced audio inputs. Speak to your retailer for further information.

If the disc tray gets jammed while closing, the tray will stop and open automatically. If this happens check the disc tray and reload the disc correctly.

5. When the disc is loaded correctly the the player will spin the disc to read the T.O.C. (Table Of Contents). This will tell the player how many tracks are recorded on the disc and how long they are. Depending on the number of tracks and the method of recording the information, the T.O.C. read can vary from 3 - 10 seconds or more. Until this has been achieved, no other function will work. When the T.O.C. is correctly read the player will display the information.

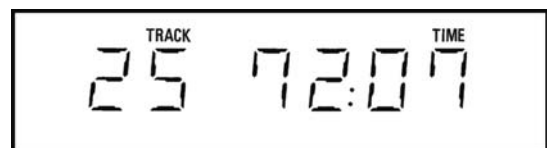

For example above:

There are 25 tracks on the disc. The total playing time is 72 minutes and 07 seconds. The player is set to play when required.

NORMAL DISC PLAY

Before playing a disc, check the player's power cable and output cable connections.

1. Switch on the CD53 at the rear panel, a yellow LED will light above the power button.
2. Press the **STANDBY** switch and the LED will turn green.
3. Press the **OPEN/CLOSE** or **DISC** button to open the disc tray and load the disc.
4. Press the **OPEN/CLOSE** or **DISC** button again to close the disc tray.

N.B. If you get a message **disc** on the display when the disc tray is fully closed, this means that the disc is improperly loaded (most likely upside down). To check, open the disc tray again and reload the disc correctly.

6. Press the **PLAY** button. The **PLAY** symbol will appear on the display. The disc will start playing from the beginning of the first track.

You may also go straight to a specific track by using one of the **SKIP** buttons **⏮** or **⏭**. In this case the disc will start playing the selected track when the **PLAY** button is pressed. The numeric keys on the remote handset allow direct access to the desired track.

- 7. At the end of the last track the CD will return to a waiting mode.

NOTES:

- ◆ If the CD is deeply scratched, too dirty, or not recorded to Sony/Philips 'Red Book' standards, the disc may not play. If an improperly centered disc is played, noise will be heard in the mechanism. Avoid using such discs.
- ◆ Some discs of poor manufacture may not be readable or may skip. Check another disc should this occur.
- ◆ Some discs will take longer to read the T.O.C. if they have a lot of tracks, i.e. more than 25.

OPERATION
◆ STANDBY

When switching-on from Standby, with no disc in the tray, the display will show *no disc*.

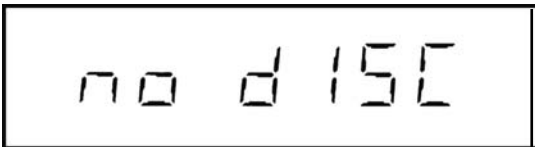

If there is a disc in the tray the *track* display will show *disc* until the T.O.C. (table of contents) has been read.



When the T.O.C. has been read, the information will be displayed, i.e. the total *number of tracks* and total *playing time*.

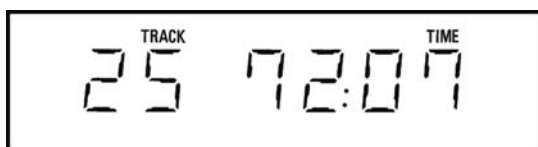

◆ INSERTING A DISC

Press the **OPEN/CLOSE** button on the front panel or **DISC** on the handset, the disc tray will open and the **OPEN** sign will be displayed.

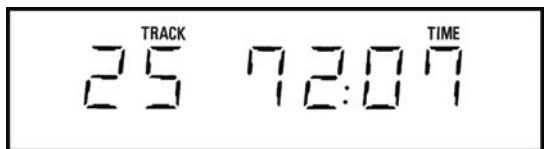

Insert the disc and press the **OPEN/CLOSE** or **DISC** button again to close the tray.

The disc will start spinning and the total number of tracks will be read. The disc will then stop and the display will show the **T.O.C.** (table of contents), being the total *number of tracks* and the total *playing time*.



◆ TO PLAY A DISC

Press the **PLAY** button. The disc will start playing.

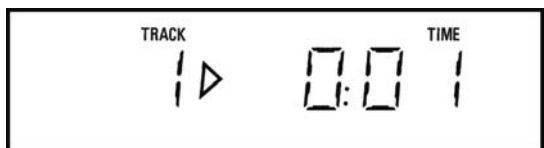
The *track* number **1** will be displayed, together with the **PLAY** ► symbol and the elapsed *time* of the track being played.

◆ TO 'STOP DISC PLAY

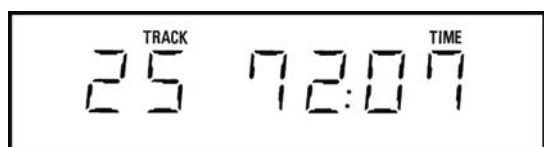
Press the **STOP** button. The disc will stop playing, the **PLAY** ► symbol will disappear and the *track* indicator will show the total number of tracks. The *time* indicator will display the total playing time.



◆ **TO 'PAUSE' THE DISC PLAY**

Press the **PAUSE** button. The disc will stop playing at the current play position and **PAUSE** will be displayed.



Press the **PAUSE** button again or press **PLAY** to resume disc play. **PAUSE** will disappear.

CHECK THE DISK AND TRACK REMAINING TIME

(Remote control only)

During normal disc play, when the **TIME** button on the Remote control is pressed, the **REM** symbol will light up and the remaining playing time of the track will be displayed.

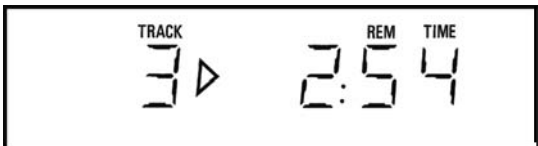

Pressing the **TIME** button twice will show the remaining playing time of the disc; the **REM** and **TOTAL** symbols will be displayed.



When the **TIME** button is pressed for the third time, the time indicator will return to the elapsed time of the track being played.

TO LISTEN TO A DESIRED TRACK

Press the **SKIP FORWARD** or **SKIP BACK** button to select a desired track. The track number of the selected track will be shown on the **track** display.

◆ **'SKIP FORWARD' TO THE NEXT TRACK**

To skip ahead to the beginning of track 5, for example, while track 4 is playing, follow the steps below:

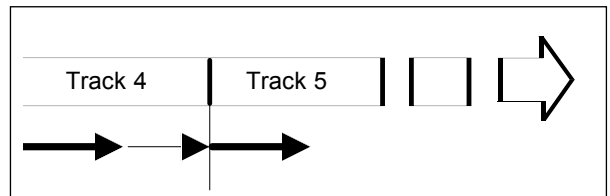

Press the button on the front panel, or the button on the remote handset once.



The player will skip to the beginning of the next track.



Disc play starts with track 5.



The CD player will skip ahead to the next track each time the or button is pressed.

Continuously pressing the or button makes the CD player skip ahead through the disc, track by track, until you reach the desired place. The CD player can be advanced to the last track in this way. When the last track is reached, the CD player will return back to track 1.

◆ 'SKIP BACK' TO THE PREVIOUS TRACK

To skip to the beginning of track 3, for example, while track 4 is playing, follow the steps below:

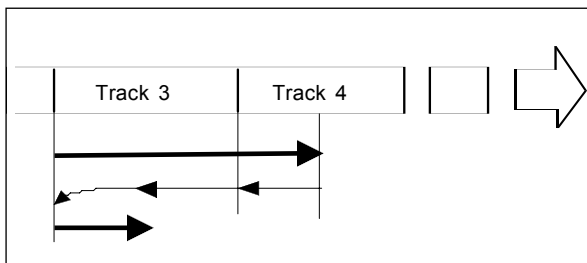

Press the button on the front panel, or the button on the remote handset twice.

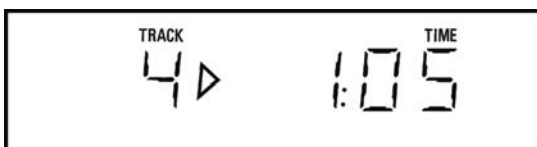

The player will skip to the beginning of the current track.



Press the or button again.



The player will skip to the beginning of the previous track.

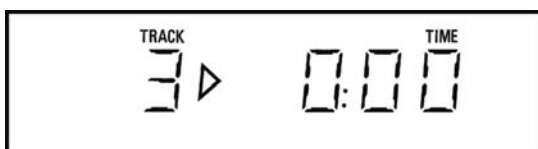

Disc play will start from track 3.

◆ TO SEARCH QUICKLY FOR A PARTICULAR POINT OF A TRACK

During **PLAY** mode press and hold the or buttons for fast-forward and fast-back operation.

During **PLAY** mode:

When or button is pressed, the sound will be muted to about 1/4 of the normal volume level for the duration of the fast-forward or fast-back operation.

During **PAUSE** mode:

Pressing or buttons will release the pause mode and the search will continue normally with a muted sound.

During the or operation, for the first few seconds the player will search slowly through the disc and then switch to searching fast.

◆ FAST SEARCH

(Remote control only)

Using the remote control only, the fast search can be enabled by pressing the **FAST** button before pressing the search or buttons.

◆ 'SHUFFLE PLAY'

Use this feature to play tracks on a disc in a random order.

1. Press the **Shuffle** button on the front panel. This function is not available from the remote.
2. Press the **PLAY** button. A track will be randomly selected and the disc will start playing.
3. Press **Shuffle** during **Play** and the remaining tracks will be shuffled.

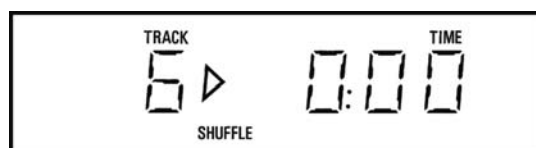

PROGRAMMED DISC PLAY

(Remote control only)

This feature allows you to play tracks in your preferred sequence.

It is not possible to program the CD player while the disc is playing. So, press the **STOP** button first, then enter a program.

◆ ENTERING A PROGRAM

To program a desired sequence of tracks:

1. Select the first track using the or numeric 0-9 buttons. Press the **PROG** button on the remote handset. The **MEMORY** symbol will illuminate and the track number will be displayed. The first selected track is now stored in the memory.
2. Select the next track number using the or numeric buttons. Press the **PROG** button again - the second choice is now stored in the memory.
3. Repeat the steps above until all the desired tracks are stored in the memory.

EXAMPLE

To play track 5, track 2 and track 8 in sequence:

Enter the first choice by selecting track 5 using the or numeric button. Press the **PROG** button to store the first choice. Track **5** is now stored and the **EDIT** symbol will be displayed.



The **time** display will toggle between **P: 1** and the playing time of the selection.

Enter the second choice - track 2 using the or numeric button. Press the **PROG** button to store the second choice. Track **2** is also stored.

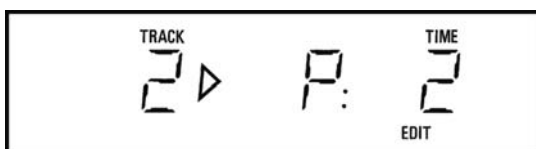

Enter the third choice - track 8 in the same way. Press the **PROG** button to store the third choice.



Press the **PLAY** button. The first programmed track will start playing and the **PROGRAM** symbol is displayed.



◆ LISTENING TO A PROGRAMMED SEQUENCE

1. Press the **PLAY** button. The **PLAY** symbol will be displayed.

2. The disc will start playing the first programmed track.

NOTE: A maximum of 16 tracks only can be stored in the **PROGRAM** memory.

3. After the programmed sequence has finished playing, the **track** display and the **time** display will show the number of tracks played and the total playing time.

◆ CHANGING THE PROGRAM

1. Press the **STOP** button if the disc is playing.
2. You can modify the program by entering new track numbers.

◆ CLEARING THE MEMORY

1. Press the **STOP** button twice if the disc is playing.
2. Press **OPEN/CLOSE** button twice on the front or **DISC** button on the handset.

NOTE: The memory will also be cleared if the power is switched off on the rear panel.

REPEAT DISC PLAY

Use the **REPEAT** button to repeat a track, all tracks on the disc, or a programmed sequence of tracks.

◆ 'REPEAT' ONE TRACK

Make sure that the **PROGRAM** function has not been selected.

1. Press the **REPEAT** button once and the **REPEAT 1** message will appear.
2. Select the desired track using the or or numeric buttons. The track number will appear on the **track** display.
3. Press the **PLAY** button. The **PLAY** symbol will be displayed and the selected track will start playing.

NOTE: You can also select **REPEAT** mode while the desired track is playing.

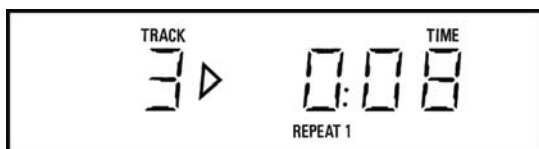

4. At the end of the track the CD player will automatically return back to the beginning. The track will continue to repeat until the **STOP** button is pressed.
5. Alternatively, to cancel **REPEAT 1** press the **REPEAT** button twice, to toggle pass **REPEAT ALL** and back to normal **PLAY** mode.

◆ 'REPEAT ALL' TRACKS ON THE DISC

1. Press the **REPEAT** button twice and the **REPEAT ALL** message will appear.
2. Press the **PLAY** button and the disc will start playing.

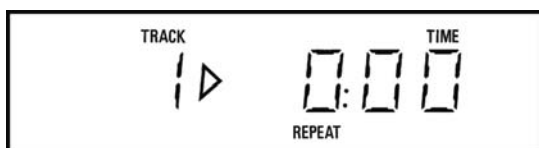

3. At the end the last track the CD player will automatically return to the beginning of the first track. The repeat play will continue until the **STOP** button is pressed.

NOTE: You can also select **REPEAT ALL** mode while the disc is playing. At the end of the last track the disc will automatically return to the beginning of the first track and will continue playing until **REPEAT ALL** is cancelled.

5. If the **REPEAT** button is pressed again, the **REPEAT ALL** message will disappear and normal play will resume.

◆ 'REPEAT' A PROGRAMMED SEQUENCE OF TRACKS

1. Enter a program.
2. Press the **REPEAT** button twice and the **REPEAT ALL** message will appear.
3. Press the **PLAY** button, the **PLAY** symbol will be displayed and the programmed sequence will start playing.
4. All programmed tracks will continue playing in order until the **STOP** button is pressed.
5. If the **REPEAT** button is pressed once more, the **REPEAT ALL** message will disappear and Program mode will resume.

◆ 'A << B' DISC PLAY

(Remote control only)

Use to repeatedly play a portion of the disc, from point **A** to point **B**.

1. Press the **PLAY** button.

Go to the starting point of your selection using and keys and press the **A/B** button.

The **REPEAT** message will appear, with the letter **B** flashing, and point **A** will be stored in the memory.

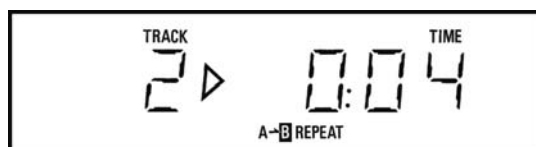

2. Press the **A/B** button again at the end point of your choice.

The letter **B** will stop flashing and point **B** will be stored in the memory. The segment between **A <> B** will be repeatedly played.

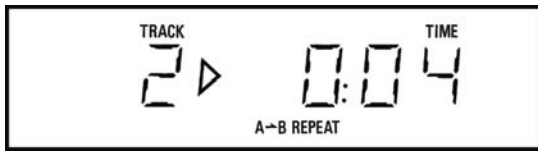

- To clear REPEAT **A ↔ B**, press the **A/B** button or the REPEAT button once.

◆ INTRO / SCAN MODE

(Remote control only)

The INTRO/SCAN feature allows you to listen to the first ten seconds of each track in turn so you can evaluate a disc or choose your preferred track.

- Press the **SCAN** button, the INTRO message will appear on the display.

Press PLAY for the first track to start playing.



- You can listen to the beginning of each track during RANDOM/SHUFFLE and REPEAT ALL functions.

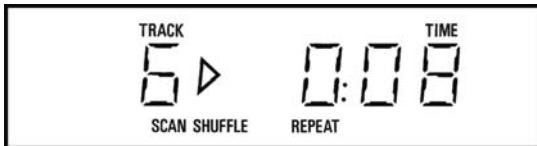

- You can listen to the beginning of the selected tracks during a PROGRAM function.



- To clear the INTRO/SCAN function press the **SCAN** button again.

◆ NUMERICAL KEYS ON THE REMOTE CONTROL

To save time tracks can be chosen by pressing any numerical keys.

- For tracks 1 to 10:**

If you want to listen to track 4 for example, press the No 4 button. The track indicator will show 4.



Press PLAY, the PLAY symbol will appear and track 4 will start playing.



NOTE: You can select a desired track while the disc is playing, i.e. if you want to listen to track 4, just press No 4 button and track 4 will start playing.

- For more than 10 tracks:**

If you want to listen to track 14, press button 1 + button 4 within 2 seconds.

The track indicator will show track 14.



If the CD50/CD53 is already running track 14 will start playing automatically.

If not, press PLAY and track 14 will start playing.



TROUBLESHOOTING GUIDE

If you have followed the instructions, and are having difficulty operating your compact disc player, please use the simple guide below to help you solve the problem. Here we have listed the most common hiccups experienced by the users, which we hope will be of some help.

Locate the SYMPTOM in table below and then check the corresponding POSSIBLE CAUSE and CORRECTIVE ACTION to remedy the problem.

SYMPTOM	POSSIBLE CAUSE	CORRECTIVE ACTION
No power when the power switch is ON.	Poor power plug connection at the AC outlet. Fuse in the mains plug has blown. CD player is in standby mode.	Insert the power plug firmly into the AC outlet. Replace the fuse in the mains plug. Press Standby button.
Disc play does not read T.O.C.	The disc is loaded upside down. The disc is too dirty or scratched. A DVD or SACD is being used.	Reload the disc with the label side up. Clean the disc. Replace the DVD with a CD disc.
No sound.	Improper output cable connections. Improper amplifier operation.	Connect the output cable properly. Make sure that the amplifier controls are set properly.
Sound skips.	Damaged, faulty or dirty disc. The CD player is subject to vibrations or physical shock.	Clean or replace with a new disc. Change the location of the player.
Programmed sequence will not play.	The CD player is in the normal disc play mode.	Press the STOP button and then program the tracks. see Program guide in manual.
Humming noise.	Loose cable connections. Local interference.	Press plugs in firmly. Move CD53 to new location.
Remote handset will not function.	Batteries low.	Replace the batteries .



Creek

**12 Avebury Court, Mark Road,
Hemel Hempstead, Herts, HP2 7TA England.**

Tel: + 44 (0)1442 260146

Fax: + 44 (0)1442 243766

E-mail: info@creekaudio.co.uk

Internet: www.creekaudio.co.uk

*Creek Audio Limited reserves the rights
to modify or change the specification of
its products without notice.*